

CURVED A

2000mm H x 2000mm W

-  Visible Graphic Area 2000mm x 2000mm
-  Finished Print Size 2000mm x 2000mm
(inc. 150mm inside base of cassette)
-  Image Bleed Area 2010mm x 2010mm
(10mm sides, 1000mm inside base)

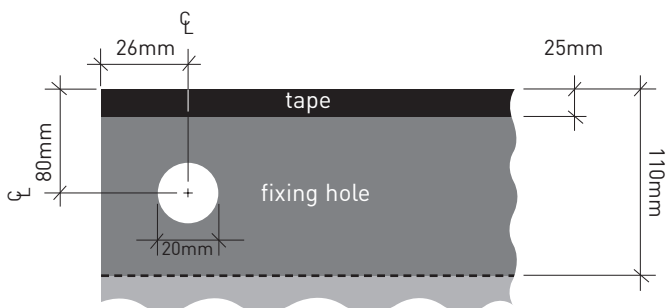

Fixing Hole Diagram:

- 26mm from outside edge to centre.
- 80mm from trimmed end to centre.
- Hole Diameter 20mm.

110mm extra for overlap based on using 25mm wide double-sided tape to secure graphic. This makes a 85mm pocket.

----- Graphic folding edge/crease line



ORDER LINE:
0845 8854 460