

**2000mm H X 3000mm W**  
**LCD GRAPHIC**

-  Visible Graphic Area 2000mm x 3000mm
-  Finished Print Size 2000mm x 3000mm  
(inc. 150mm inside base of cassette)
-  Image Bleed Area 2010mm x 3010mm  
(10mm sides, 1000mm inside base)

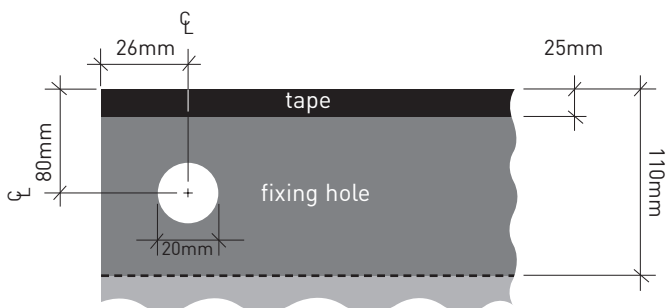

**Fixing Hole Diagram:**

- 26mm from outside edge to centre.
- 80mm from trimmed end to centre.
- Hole Diameter 20mm.

110mm extra for overlap based on using 25mm wide double-sided tape to secure graphic. This makes a 85mm pocket.

----- Graphic folding edge/crease line



**ORDER LINE:**  
**0845 8854 460**